

P Item	CODICE Code	DESCRIZIONE Designation
1	ZA91231	Cartuccia completa Ø25mm
2	ZGHI030..	Ghiera fermacartuccia (NUOVA) M30x1
3	ZCAP062..	Cappuccio sottoleva in metallo
4	ZPIA110..	Piastra in acciaio inox 2 fori con guarnizioni
5	ZBOC108..	Bocca con aeratore l.200mm
6	ZAER090	Aeratore M24x1 SLIM AIR con chiavetta
7	ZLEV150..	Leva completa EFFE

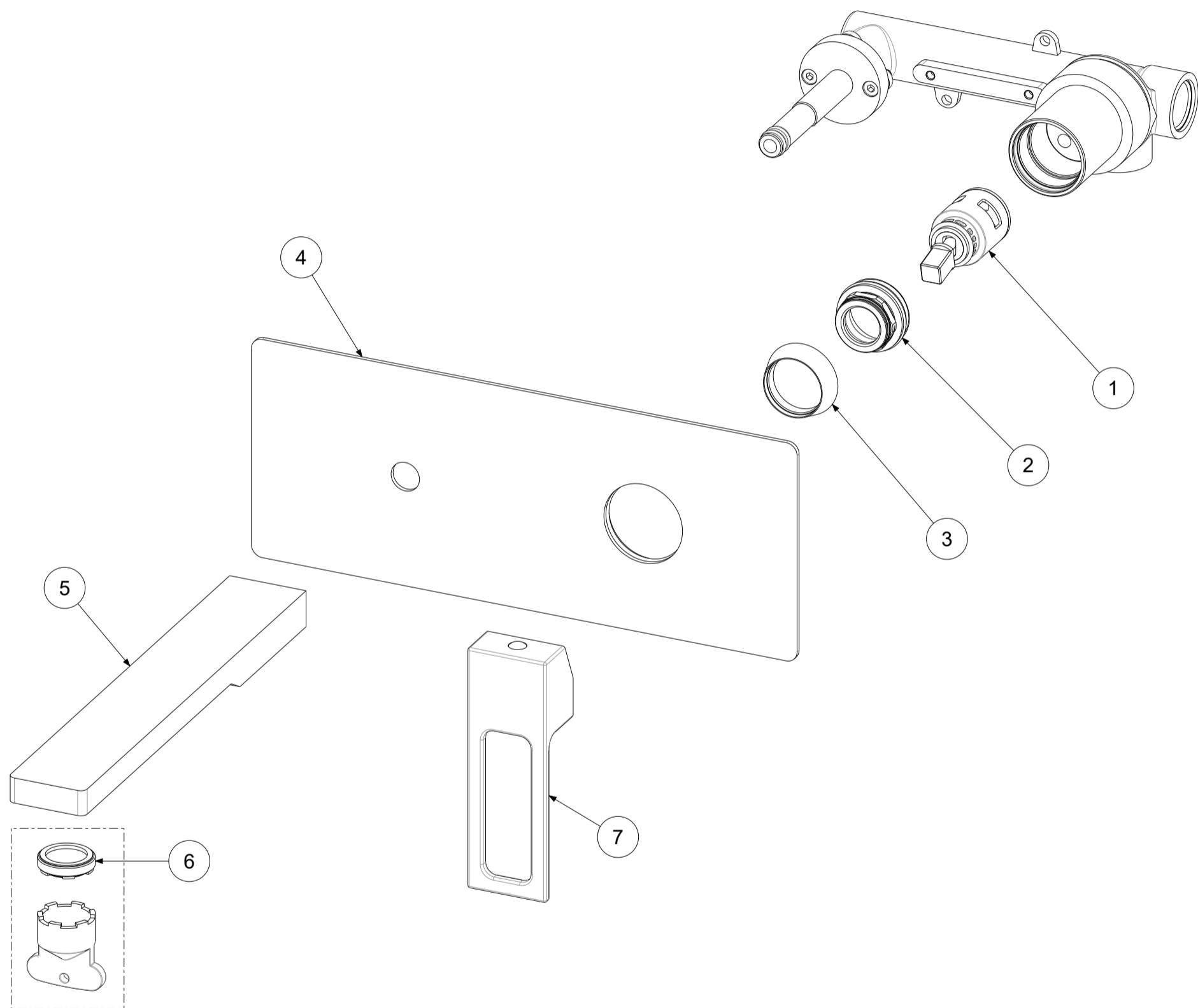

	APPROVATO: Approved:		A3	SCALA Scale	1:2	MATERIALE Material	VARI
	DISEGNATO: Design:	Bertoli	14/06/2021	UNITA' Unit	mm	SERIE Range	EFFE
	DESCRIZIONE - Description: Miscelatore incasso 2 Fori c/Piastra rettangolare e bocca mm.200 EFFE Concealed single lever basin mixer						
FOGLIO - Sheet:		Ricambi	CODICE - Part Number:		EF105CR		